

# **FITEXPO**

**FITNESS & WELLNESS EXPERIENCE**

# **CONFORT 54**

**54M<sup>2</sup> (9X6M) SPACE WITH STAND INCLUDED**

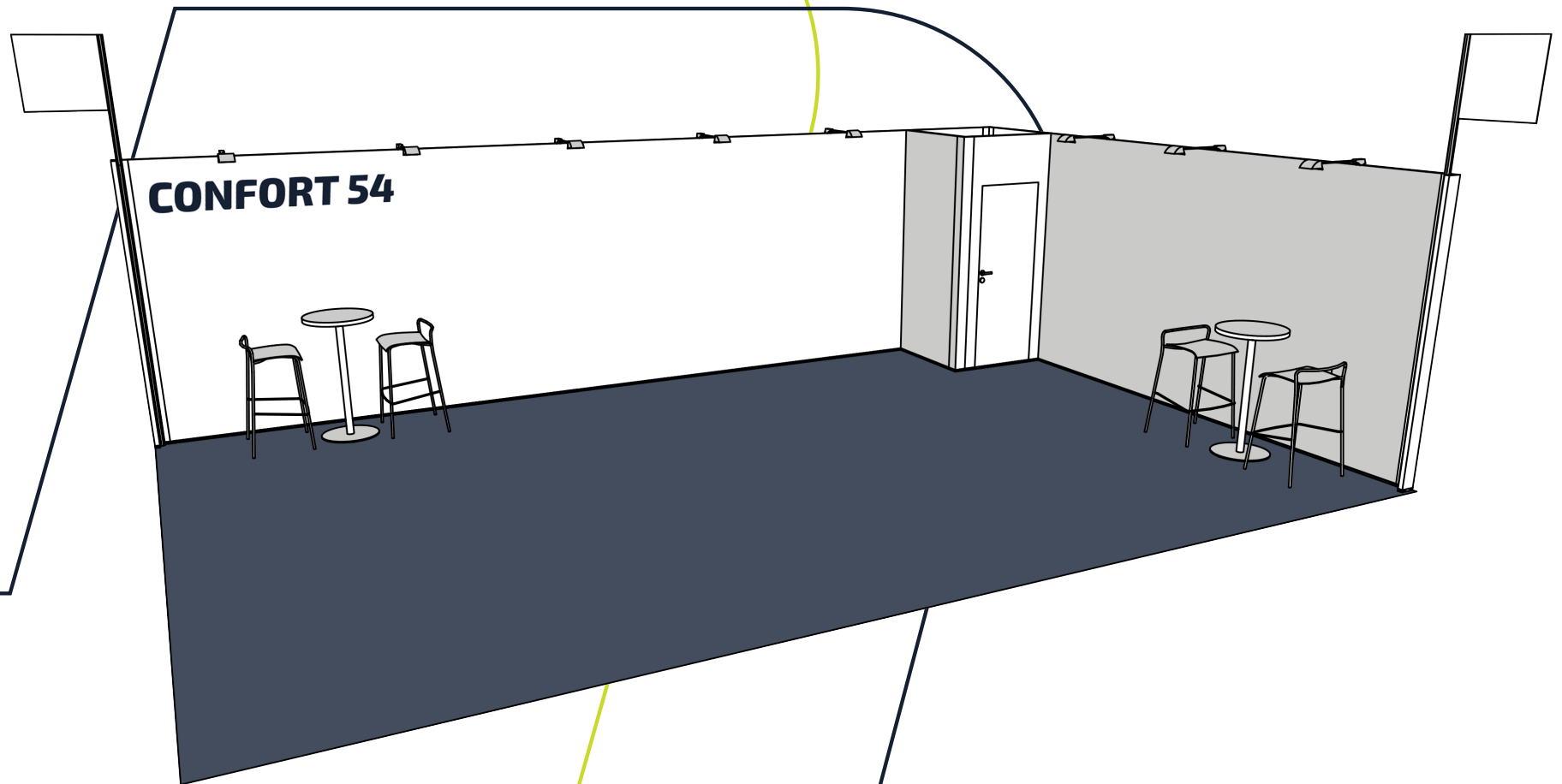

# CONFORT 54

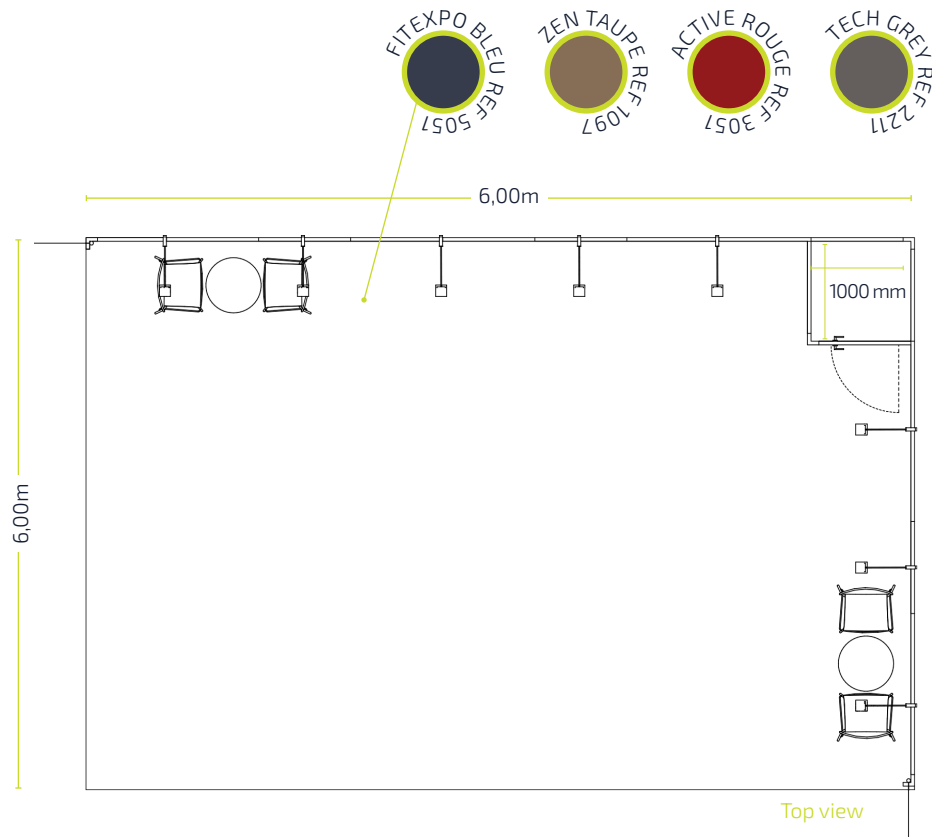

Top view

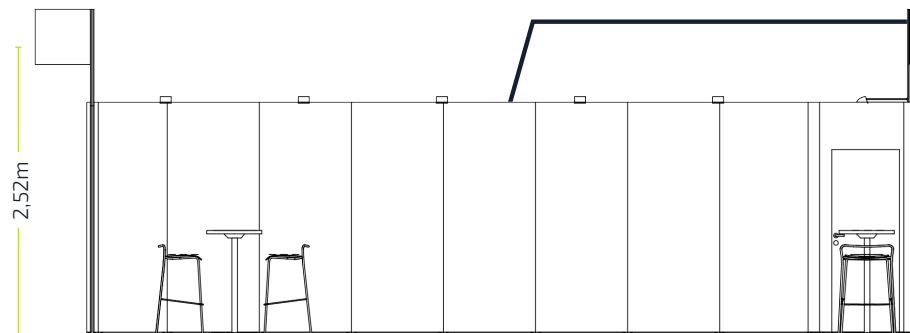

Front View

## Comfort Package

The package includes:

- 54m<sup>2</sup> (9 x 6 m) space with stand included
- Carpet of choice:
  - Fitexpo Bleu Ref. 5051
  - Zen Taupe Ref. 1097
  - Active Rouge Ref. 3051
  - Tech Gris Ref. 2211
- Gilnhammer structure and white melamine-coated panels
- Reserve of +/- 1 m<sup>2</sup>
- 3x 600 x 600 mm double-sided sign with stand number, colour logo and exhibitor name
- 8x spotlights

*Graphic design work is not included in the price calculation and may be the subject of an additional offer at the standard rate of €110 (excl. VAT) per hour, excluding index 2024.*

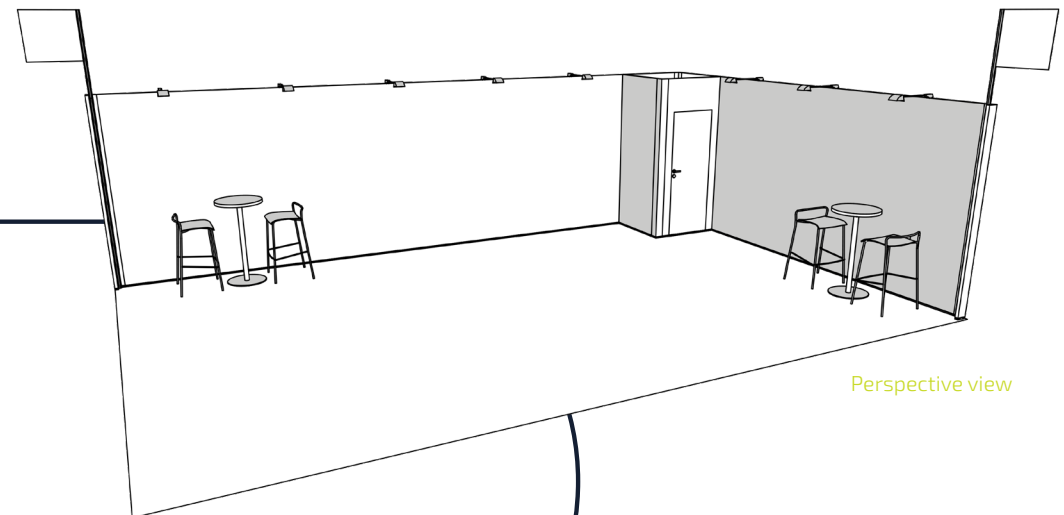

Perspective view

# CONFORT 54

## PRINT SPECIFICATIONS

- Panel size: 1000 x 2500 mm
- File size: 1:10, minimum 1000dpi, optimum 1500dpi
- 1mm bleed (1:10 scale) and no crop lines
- Flattened transparency
- Vectorised fonts
- File type: PDF x-4, CMYK
- If required, please send colour references or specify Pantone reference
- Colours may vary slightly depending on the material.

## SIZE OF VISUAL

As of 1m<sup>2</sup> / tailor-made

## Vinyl Option

The vinyl option includes:

- Printing of your visual on vinyl starting at 1m<sup>2</sup>
- Price calculated per m<sup>2</sup>

**Price (excl. VAT): 120€ / panel** (complete customisation: 39m<sup>2</sup> wall surface)

*Graphic design work is not included in the price calculation and may be the subject of an additional offer at the standard rate of €110 (excl. VAT) per hour, excluding index 2024.*

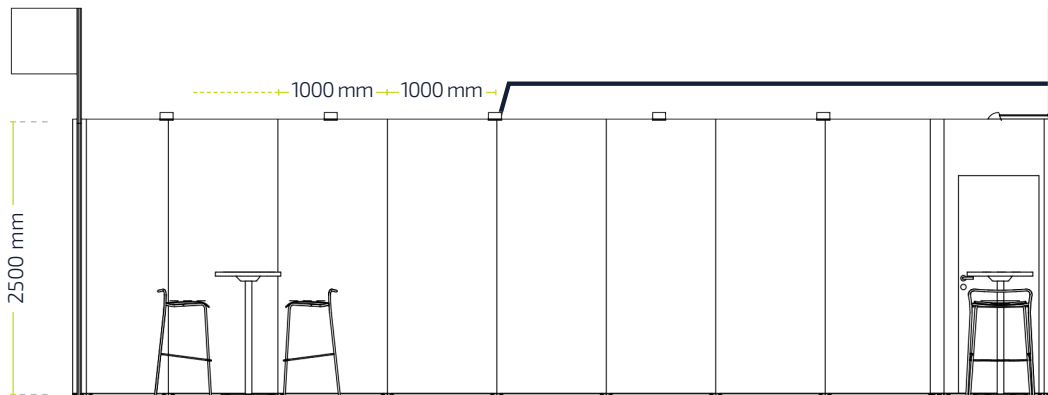

Technical Details

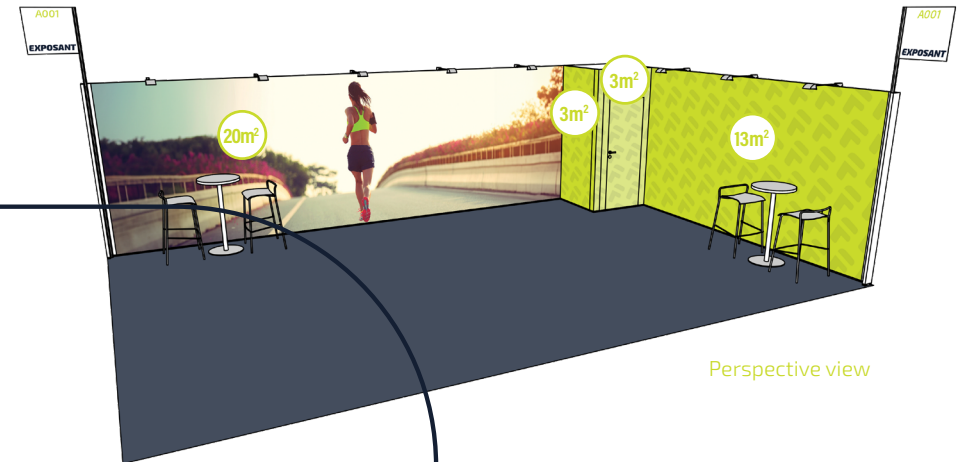

Perspective view

# CONFORT 54

## ***Additional supplies***

Contact us for all types of additional supplies or furniture.



***and much  
more...***

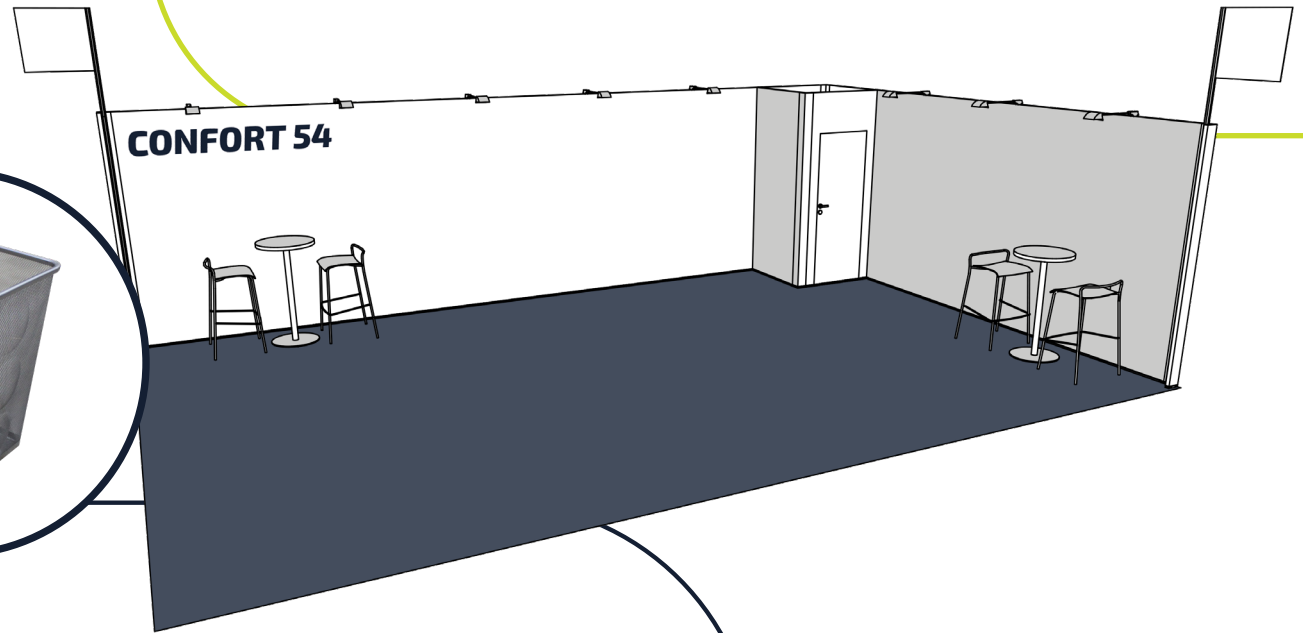

# CONFORT 54

## Communication materials

Contact us for all types of additional communication materials.



and much  
more...

**Calicots**

# PACKAGES

## PACKAGES "BASIC EXHIBITOR"

## PACKAGES "PREMIUM EXHIBITOR"

### BASIC 9

### BASIC 18

### BASIC 36

### COMFORT 18

### COMFORT 36

### COMFORT 54

	PACKAGES "BASIC EXHIBITOR"			PACKAGES "PREMIUM EXHIBITOR"		
	BASIC 9	BASIC 18	BASIC 36	COMFORT 18	COMFORT 36	COMFORT 54
<b>Rates</b> (Prices excl. VAT)	1.260 €	2.340 €	4.320 €	4.680 €	8.658 €	16.017 €
<b>EXCEPTIONAL DISCOUNT OF 10%</b> until 15/07/2024	<b>1.134 €</b>	<b>2.106 €</b>	<b>3.888 €</b>	<b>4.212 €</b>	<b>7.792 €</b>	<b>14.415 €</b>
<b>Allocated bare surface</b>	9m <sup>2</sup> (3 x 3m)	18m <sup>2</sup> (6 x 3m)	36m <sup>2</sup> (6 x 6m)	18m <sup>2</sup> (6 x 3m)	36m <sup>2</sup> (6 x 6m)	54m <sup>2</sup> (9 x 6m)
<b>Additional m<sup>2</sup></b> (Subject to availability)	140€/m <sup>2</sup>	130€/m <sup>2</sup>	120€/m <sup>2</sup>	130€/m <sup>2</sup>	120€/m <sup>2</sup>	110€/m <sup>2</sup>
<b>Reserve</b>				1m <sup>2</sup>	1m <sup>2</sup>	1m <sup>2</sup>
<b>Stand</b>	Basic	Basic	Basic	Comfort	Comfort	Comfort
<b>N° of free sides</b>	1	1	1	2	2	2
<b>Partitions / partition lights</b>	Included	Included	Included	Included	Included	Included
<b>Carpet</b>	Included	Included	Included	Included	Included	Included
<b>WI-FI</b> (+LAN on demand)	Included	Included	Included	Included	Included	Included
<b>Electricity connection</b> 3KW = 90€ / 12KW = 300€ / 40KW = 575€ (Consumption not included)						
<b>N° of exhibitor badges</b> (10€ per additional badge)	2	4	6	4	6	8
<b>N° of parking badges</b> (150€ par additional badge)	1	1	1	1	1	2
<b>Digital "Invite" tickets</b> (Personalised with your logo / Additional digital tickets: 15€ per 10)	10	20	40	30	40	60
<b>DIGITAL</b>						
<b>Website</b> www.fitexpo.lu	Logo	Logo	Logo	Logo	Logo	Logo et Présentation
<b>Social media</b> (Facebook, Instagram, LinkedIn, Tiktok, Youtube, Snpshat)	Text, visual or video delivered by the exhibitor	Text, visual or video delivered by the exhibitor	Text, visual or video delivered by the exhibitor	Text, visual or video delivered by the exhibitor	Text, visual or video delivered by the exhibitor	Text, visual or video delivered by the exhibitor

Empty fields = Not included. Price on demand if needed.

# REGULATIONS

---

- 1 ORGANISERS, VENUE AND PARTICIPANTS**
- 2 DATES AND DURATION OF THE EXHIBITION**
- 3 PARTICIPATION IN FITEXPO**
- 4 BOOKING REQUEST FOR FITEXPO**
- 5 PRODUCTS ON DISPLAY**
- 6 LOCATIONS, FITTINGS AND EXHIBITOR CARDS**
- 7 STAND ASSEMBLY AND DISMANTLING**
- 8 PAYMENT**
- 9 ADVERTISING**
- 10 PRICE DISPLAY**
- 11 RETAIL**
- 12 LEGAL PROVISIONS**
- 13 LIABILITY, INSURANCE**
- 14 FLAT-RATE WASTE DISPOSAL TAX**
- 15 ACCIDENT PREVENTION**
- 16 SPECIAL PROVISIONS**
- 17 MAJOR FORCE**
- 18 VERBAL AGREEMENTS**
- 19 INNER DISCIPLINE**
- 20 DELIVERY IN THE PARTICIPANT'S ABSENCE**

## ARTICLE 1

### ORGANISERS

Audio-Idea.Lu sàrl (Positioning name: ID Communication), with its registered office in Luxembourg, has as one of its objects the organisation and staging of national and international trade fairs, exhibitions and events, as well as communication and marketing, which will hereinafter be referred to in these general rules as «the Exhibitions».

In general, the company may carry out any industrial, commercial, financial, securities and real estate transactions relating directly or indirectly, in whole or in part, to its corporate purpose. In the remainder of these general regulations, Audio-Idea.Lu sàrl (positioning denomination: ID Communication) will be referred to as «the Organiser(s)».

### PLACE AND DATE

The FitExpo is organised by Audio-Idea.Lu sàrl (Registered name: ID Communication) and will take place in the LUXEXPO S.A. buildings in Luxembourg-Kirchberg on 10, 11 and 12 January 2025. In the remainder of these general regulations, these buildings will be referred to as «the buildings».

### PARTICIPANTS

In the remainder of these general regulations, any person, company or organisation accepted by the Organisers to take part in the FitExpo will be referred to as «the participant».

## ARTICLE 2

### DATES AND DURATION OF THE EXHIBITION

The Organisers have the right to set the dates and opening times of an exhibition and reserve the right to change them at any time, without this entitling participants to any compensation whatsoever.

The date of the event is set for 10, 11 and 12 January 2025.

In the event of a change affecting the date or duration of an exhibition, the existing contracts between the participants and the Organisers shall be deemed to have been concluded for the new date or duration. These changes in date or opening hours do not give participants the right to waive, even partially, their commitments.

## ARTICLE 3

### PARTICIPATION IN FITEXPO

Only companies involved in the event (details on the registration form) may submit an application. The Organisers will have the right to refuse applications to book an exhibition without giving any reasons.

## ARTICLE 4

### BOOKING REQUEST FOR FITEXPO

The exhibition reservation request form must be completed in full, legibly and in capital letters wherever possible. By submitting a reservation request, the signatory of the request acknowledges as legally binding for him/her the conditions of the present general regulations as well as all other directives of the Organisers.

The Organisers will not consider reservation requests submitted subject to conditions or reservations.

When the Organisers have accepted a booking request, the interested party is informed by an acknowledgement of receipt. It is only with this document that the Organisers commit themselves and that the participation contract becomes effective. Acceptance of a booking request by the Organisers does not imply any guarantee of a positive commercial result for the participant.

Once an application has been acquired, it cannot be cancelled by the participant. The rental price of the stand allocated to the participant is due in all cases, even if the participant, for whatever reason, is prevented from taking part in an exhibition.

If a participant withdraws, and only after the Organisers have succeeded in finding a replacement, the participant will be released on payment of 30% of the total price of the contracted service. If the participant's pitch cannot be allocated to a replacement, the initial participation contract will not be terminated and the full rental price and other costs will remain payable.

It is formally forbidden for participants to transfer the stand allocated to them in whole or in part, in return for payment or even free of charge, to a third party, even if they have a close economic relationship with that party.



---

## ARTICLE 5

### PRODUCTS ON DISPLAY

The participant may not exhibit any products other than those corresponding to the requested exhibition sector and falling within one of the catalogue headings. The Organisers reserve the right to remove from a stand any products they deem to be in conflict with these general regulations and to store them at the participant's expense, without incurring any liability.

No product exhibited by the participant may be removed from the building enclosure before the close of an exhibition, except with the express agreement of the Organiser.

For any partnership, please inform the organisation, as this will be subject to validation. (Of course, the organisers undertake to do their utmost to satisfy exhibitors' requests).

## ARTICLE 6

### LOCATIONS, FACILITIES AND EXHIBITOR PASSES

The decision of the Organisers concerning stand location and dimensions shall be final. The Organisers will group participants according to the nature of the products exhibited (if possible) and according to the pillar to which they belong.

Participants will not have a choice of location, but the Organisers will take into account participants' wishes as far as possible.

Should unforeseen circumstances force them to do so, the Organisers reserve the right to modify the distribution plans of an exhibition or the dimensions of the sites without participants being able to claim any right to compensation whatsoever.

If the surface area of a pitch is reduced as a result of such a change, the Organisers will refund the difference in the resulting rental price. Pitches must have a total surface area of a multiple of one square metre.

Under certain conditions, the Organisers may be asked to fit out the sites. In this case, they will provide floor risers, floor mats, partition walls, sales counters, display cabinets, chairs, armchairs and tables, refrigerators, sinks, etc. at fixed rental prices.

Details of these supplies are given either directly on the reservation request document or in the exhibitor's guide, which will be sent to participants once their stand has been definitively allocated.

For all orders for stand equipment placed directly with the Organisers, the rental price for partitions is payable integrally, even if a partition separates two different stands. It is strictly forbidden to perforate, nail or damage stand components in any way whatsoever, to paint them or to stick objects of any kind on them. Lettering on the picture rails must be done exclusively with adhesive letters. Any infringement of the above will be invoiced to the participant.

Any service that goes beyond the normal assembly of stand components will be invoiced to the stand management. Participants will also be responsible for the cost of any partitions used to support the stand structure. The Organisers will be responsible for the heating and general lighting of the buildings.

The costs of connecting a site to the water, electricity, telephone and television networks, as well as the costs of consumption, must be paid by the participant within 10 days of the date on which they are charged to him, whether by actual invoicing or by an advance bill (see Article 8 - Payment).

Site layout plans must be submitted to the Organisers for prior approval. Any site installations that do not comply with the plans may be removed or modified at the expense of the participants, without entitlement to compensation.

Stands must be presented in a way that fits in harmoniously with an exhibition. The height of partition walls may not exceed 2.50 metres from the bare floor without prior authorisation.

Participants are responsible for the cleanliness of the area around their stand. They must not obstruct or encroach on the aisles, and must under no circumstances disturb their neighbours (see also Article 9 - Advertising).

Participants are responsible for the equipment made available to them by the Organisers. They may not transfer, lend or sublet it.

The participant is presumed to have received the equipment in perfect condition for use and is obliged to return it in the same condition.

In the event of damage, loss or breakage, the customer will be billed for compensation up to the new catalogue price of the rented equipment or equivalent new equipment.

If the equipment is subsequently returned, the period of immobilisation between the end of the event and the date of return will be considered as an extension of the hire period and invoiced as such.

For certain equipment, the Organisers reserve the right to require the participant to pay a deposit in advance.

Once the invoice has been paid in full, exhibitor and assembly passes can be collected from the Organisers' Office against receipt. These passes may not be sold under any circumstances. Exhibitors and their employees are responsible for any fraudulent use of these passes. In the event of abuse, the cards will be confiscated by the Organisers.

### INSTALLATION AND POWER CONSUMPTION

Rated voltage is 400 volts three-phase or 230 volts single-phase. Connections are made via individual meters, single-phase or three-phase U.E. sockets. The Organiser(s) shall be solely responsible for the distribution of electrical current (supply and connection).

Special stand installations carried out by the Organiser(s) will be invoiced at the prices indicated on the booking request.

Stand installations carried out by the exhibitor's qualified personnel are subject to prior authorisation by the Organisers. These installations must comply with the OIN regulations in force and the requirements of the Service d'Électricité de la Ville de Luxembourg.

It is strictly forbidden to connect more power without authorisation than that agreed with the Organiser(s).

Connection and energy consumption costs are invoiced with all other services. Except in special cases, the amount paid is a deposit, and the final invoice for the electricity service may give rise either to a credit note (refund) or to additional invoicing based on actual consumption recorded on the meter.

It is forbidden to remove the fuses from the power supply sockets without the Organisers' authorisation.

### WATER, SEWAGE

In principle, the water and sewage installation points located in the halls allow each stand to be connected to the distribution network. Exceptionally, however, a stand may have to be supplied from a water point located on the neighbouring site. For this reason, an Exhibitor whose site has one or more water points may not begin setting up his stand until he has contacted the Organisers' technical services. Under no circumstances may he object to the installation on his stand of the water inlets and outlets required to supply a neighbouring stand.

---



---

## ARTICLE 7

### STAND ASSEMBLY AND DISMANTLING

Participants must have completed the layout of their stand by 5 p.m. on the day before the opening of an exhibition. If a participant has not occupied his stand 24 hours before the opening of an exhibition, he will be considered to be in default and the Organisers will dispose of his stand without the participant being able to claim either reimbursement or compensation.

Dismantling may not begin before the end of the exhibition.

The provisions set out in the conditions of participation for the various events may modify the times mentioned above.

Set-up and dismantling passes will be issued to craftsmen and workers setting up stands. No access to the event will be authorised without presentation of this card by each participant during the official set-up and dismantling period. Any exhibit, whatever its nature and/or purpose, not removed after the end of an event within the time limit set by the Organisers may be removed by the latter, without prior formal notice, at the exhibitor's expense.

## ARTICLE 8

### PAYMENT

At the same time as their final admission, participants will receive an invoice showing the price of their pitch hire, the services and facilities (excluding equipment guide orders), and the VAT to be paid.

The payment terms and conditions will be stated on the invoice. The Organisers will determine the payment schedule.

After this deadline, participants in arrears may be excluded from the exhibition without entitlement to any compensation, and the Organisers may dispose of their stand.

Charges for electricity consumption and telephone calls will be invoiced after the event and payable immediately.

If the participant fails to meet his payment obligations, the Organisers shall be entitled to withhold items of stand equipment and/or exhibits belonging to him.

## ARTICLE 9

### ADVERTISING

Participants may only use the interior surfaces of their pitches for advertising purposes.

Advertising on behalf of a third party is prohibited. The Organisers have the right to demand the removal of any unauthorised advertising in the buildings, without having to hear the participants.

Advertising material such as flyers, brochures, leaflets or prize lists may only be distributed or displayed by participants inside their stand.

Participants are prohibited from distributing advertising items such as balloons or similar objects that might disturb other exhibitors and visitors.

The projection of slides and advertising films is subject to written authorisation from the Organisers.

The same applies to the broadcasting of music and radio or television programmes.

Participants are not permitted to organise lotteries. Competitions are subject to the Organisers' written authorisation.

It is expressly forbidden for participants to leave their stand to call visitors, just as it is forbidden to racket with a megaphone or even out loud.

Any tasting may only take place inside a stand. Crowds in the corridors caused by demonstrations must be avoided.

The Organisers may close the stand without notice if any of these infringements are observed.

## ARTICLE 10

### PRICE DISPLAY

In accordance with articles L.112-1 to L.112-9 of the French Consumer Code, the retail prices (including VAT) of all goods offered for sale must be clearly displayed.

## ARTICLE 11

### RETAIL

In principle, takeaway sales of exhibits are permitted. However, the Organisers may provide for exceptions to this general rule. In this case, the legal provisions in force in the Grand Duchy of Luxembourg concerning trading permits and the right of establishment must be strictly applied.

No authorisation will be issued for the sale of alcoholic beverages. The tasting of drinks and food products must be free of charge. Failure to comply with Luxembourg laws concerning trade permits and the right of establishment will result in the penalties provided for by the laws and regulations in force.

## ARTICLE 12

### LEGAL PROVISIONS

Participants declare that they are familiar with and respect Luxembourg law and all existing regulatory provisions. It is understood that the exclusive jurisdiction of the courts of Luxembourg is recognised, and that all notifications made to the participant, his representatives, employees or agents at an exhibition are legally valid, the participant having elected domicile in the Organisers' buildings.

The Organisers reserve the right to rule on cases not covered by these general rules.

The decisions taken will be immediately enforceable.

## ARTICLE 13

### LIABILITY, INSURANCE

As the Organisers cannot be held liable in any way or to any degree whatsoever for any loss or damage suffered by an exhibiting company, whatever the nature and whatever the cause, the Organisers have included the following insurance policies in the rental price of the sites, which they will automatically take out for the participants:

1. Legal civil liability (group contract):

Cover of €12,395,000.00 per insured event, limited to €248,000.00 for property damage and consequential damage to immovable property.

---

Sub-limitations:

- Food poisoning: €4,000,000.00 per insured event and per insurance year, regardless of the number of victims.
- Accidental damage to the environment: €2,479,000.00 per event and per insurance year, including bodily injury, material damage and consequential loss of earnings

Franchises:

- General excess: € 620.00 per insured event
- Accidental damage to the environment» deductible: 10%, with a minimum of €2,480.00 and a maximum of €24,800.00.
- It is expressly agreed and accepted by the parties that the aforementioned covenant will only have effect if for damage caused to third parties and originating within the Organisers' exhibition complex;
- if the participant has not taken out insurance covering these risks;
- if the participant's insurance contract does not include the benefits covered by the aforementioned group contract;
- after exhaustion of the cover provided by the participant's insurance contract. In such a case, the cover provided by the aforementioned contract will be reduced by the amount of the sum insured stipulated in the insurance contract taken out individually by the exhibiting company and the participant.

2. Multi-risk exhibition rental risks for the stand and products on display

Guarantees granted :

- fire, excluding electrical damage
- water damage
- breakage and damage
- burglary and robbery

Small valuables such as jewellery, stamp collections and numismatic collections are covered during the closing hours of Exhibitions, provided that they are locked in a safe. The following are always excluded from this cover

«theft» means losses resulting from simple theft and/or disappearance.

Deductible per claim and per exhibiting company for cover sub. 3. above: € 124.00.

Cover is granted to each participant up to a maximum of €248.00 per m2 rented.

For a higher value, the participant is asked to take out additional insurance.

Transport, loading and unloading risks are excluded. The above risks are covered during the exhibition period, including set-up and dismantling.

It is hereby declared that the insurance information cannot in any way bind the co-insurer companies beyond the clauses and conditions of the relevant insurance policies.

Declaration:

The participant waives any recourse that he or she may be entitled to exercise

- a) against Audio-Idea.Lu sàrl ( positioning : ID Communication)
- b) against one or more participants in the exhibition,- tenants/subtenants of the buildings of the organisations listed under a), except in the case of malicious damage.

the participant also undertakes to obtain from his own insurers a waiver of recourse in favour of the organisations mentioned under a) and of the other participants, tenants/subtenants of the buildings of the organisations under a).

Likewise, it waives any direct action it may take against the insurer of the sub. a) organisations or other participants in the exhibition or the tenants/subtenants of the LUXEXPO buildings S.A. pursuant to article 89 of the law of 27 July 1997 on insurance contracts.

## ARTICLE 14

### FLAT-RATE WASTE DISPOSAL TAX

The Organisers reserve the right to charge participants a flat-rate fee to cover the cost of waste disposal.

## ARTICLE 15

### ACCIDENT PREVENTION

The participant is obliged to equip the machines on display with a protection system that complies with the requirements of Luxembourg law.

The Organisers may prohibit the operation of any machine or appliance at any time if they are of the opinion that the operation of this machine or appliance is dangerous or could disturb one or more neighbouring participants.

The participant is solely responsible for any damage that may be caused during the set-up and dismantling periods, as well as during the duration of an exhibition, by its manufacturers, the items it exhibits or the people working on its behalf.

All goods and packaging circulate or are stored in the buildings at the participant's own risk.

## ARTICLE 16

### SPECIAL PROVISIONS

If the total space subscribed exceeds the space available, the Organisers are authorised to reduce the space allocated, or even to refuse certain reservation requests.

In certain cases, the Organisers may modify the space of stands already allocated without the participant being able to claim compensation.

Participants will not be allowed to

- using easily flammable, explosive or radiation-producing materials, gas appliances or other dangerous objects in the buildings. In the event of infringement, the objects in question will be removed without warning and at the participant's expense;
- apply or display advertising material outside or inside the stand on columns, roofs, walls, etc. forming part of the buildings;
- damage the floors, walls and roofs of the halls, or fix any objects or stand components to them using nails, screws, etc;
- damaging stand components belonging to the Organisers, e.g. painting, wallpapering or drilling holes in stand partitions;
- using signs with commercial names or brands that could mislead or harm other participants;
- unless specifically authorised by the Organisers, to erect platforms or elevations on his stand in order to build separate areas such as offices, exhibition rooms, bars, refreshment stands, etc;
- using the walls or partitions of neighbouring stands; political propaganda.

The Organisers shall be authorised to decide on cases not provided for or missing from these regulations, the conditions of participation or the exhibitors' guide.

# **FITEXPO**

**FITNESS & WELLNESS EXPERIENCE**

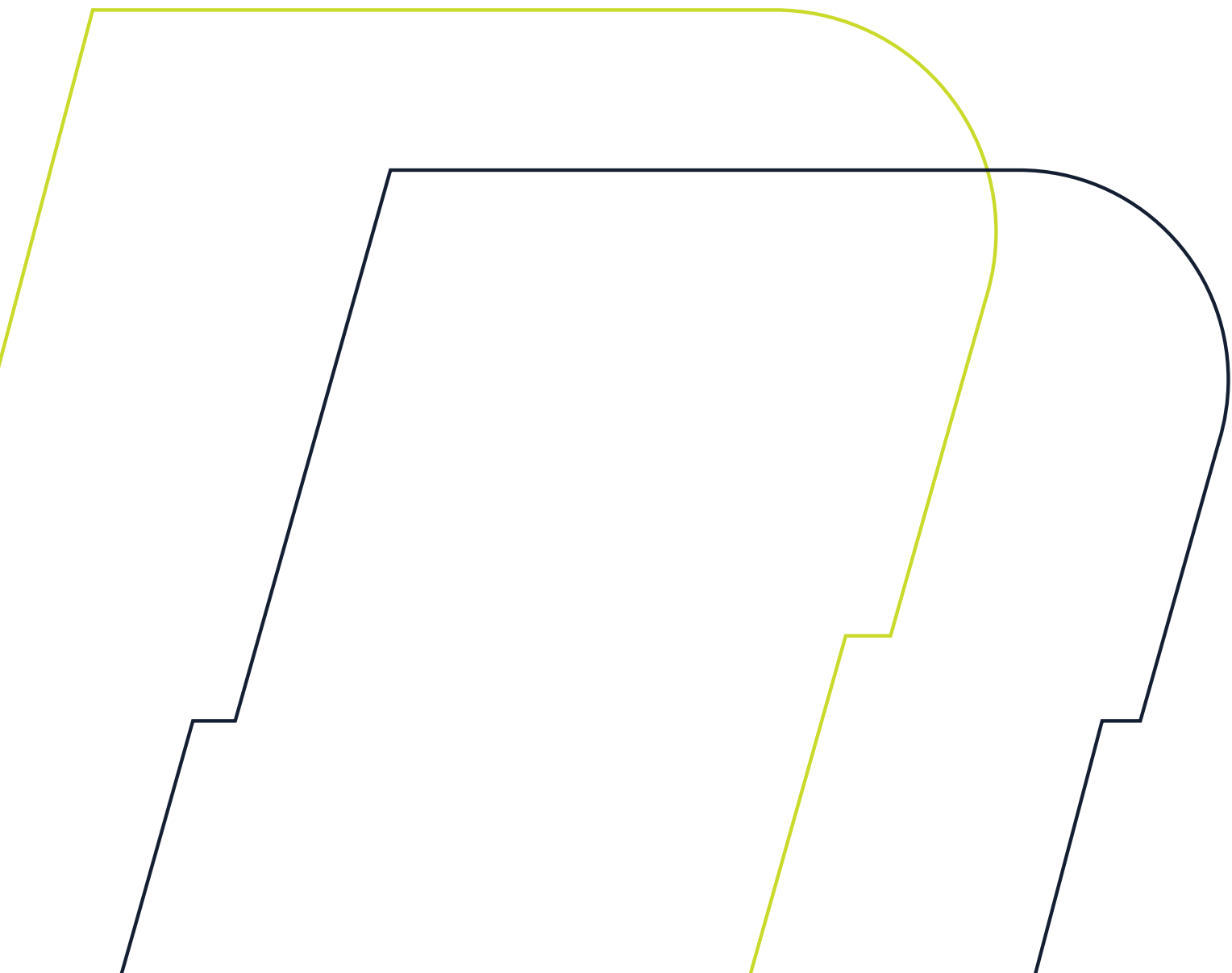

**FITEXPO.LU**